

Water Flag 5m

VERY Portable Graphic Display & Exhibition Stand Systems and Banner & Literature Stands
promoting Brands & Corporations worldwide

User Guide

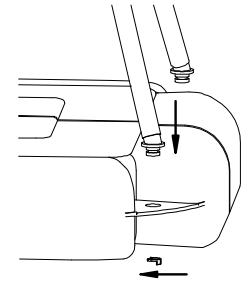
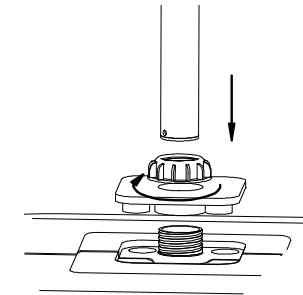
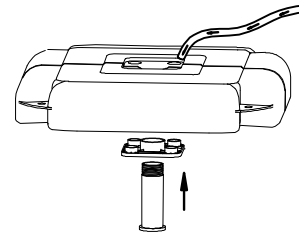
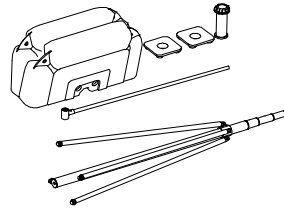
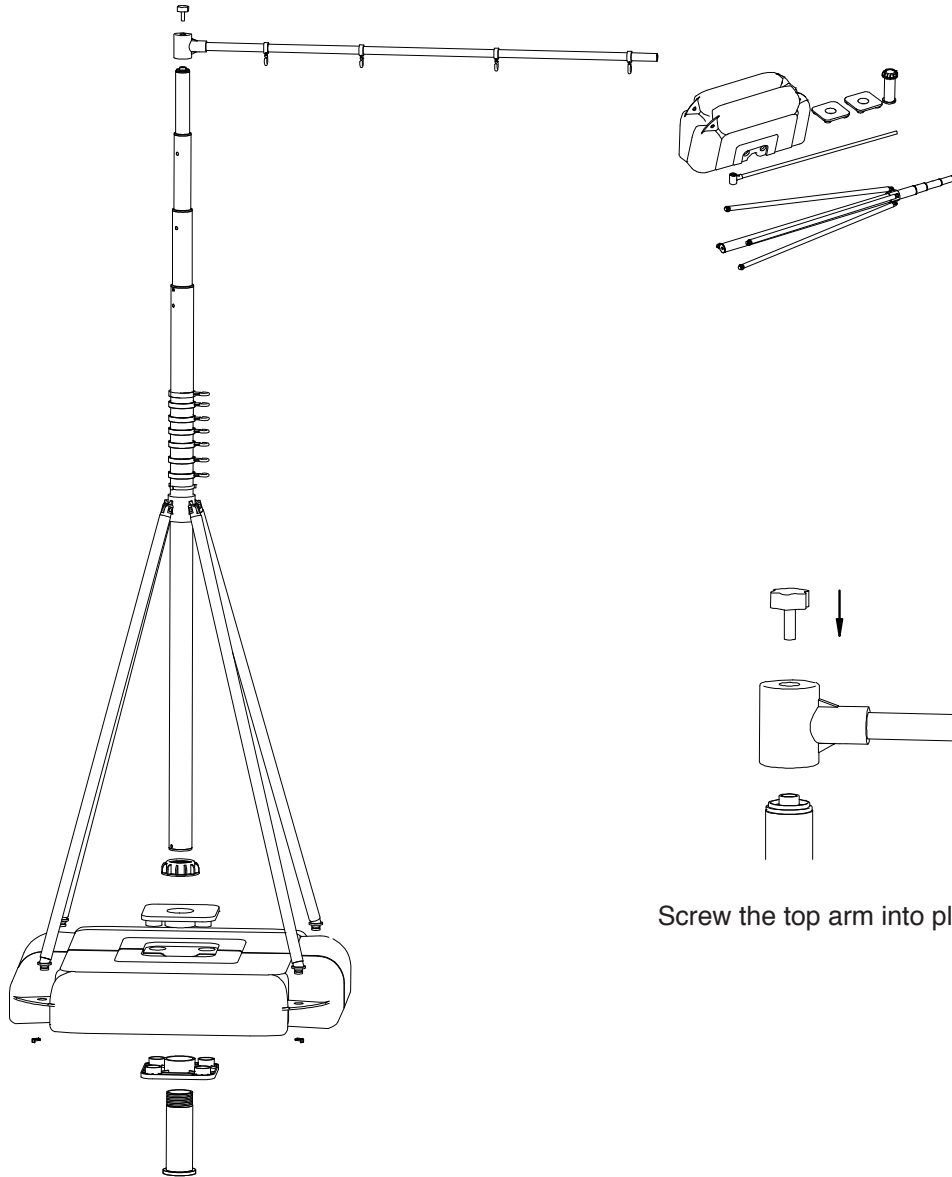

Piece together the large water base pieces fastening together as shown, and fill with water through the filling holes.

Connect the upper frame work to the base. Ensuring locking plate and nut are connected to the water base, and the supporting arms are fastened securely.

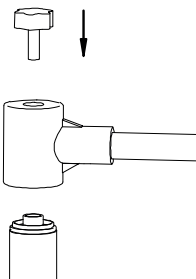

Screw the top arm into place.

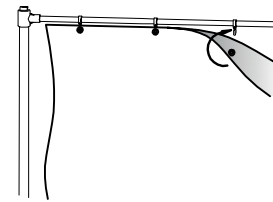

Start by attaching your flag to the top bar clips. Then by extending the vertical pole 1 stage at a time, attach the side clips.

